

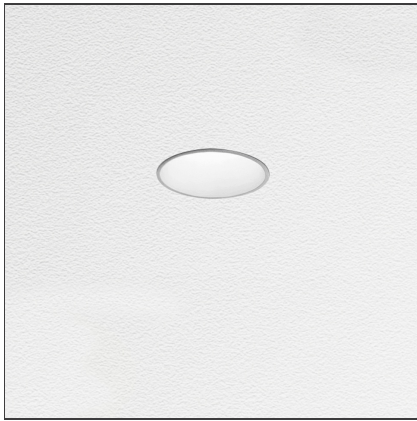

Tagora Incasso 80 - Led 3000K - 44° - White



IP20   Dimmerable: 

DESIGN BY

S./R. Cornelissen

DESCRIPTION

Series of ceiling mounted luminaires available in 4 diameters (80 mm, 270 mm, 570 mm, 970 mm), using high-output LEDs, Retrofit LEDs. Consists of a trimless recessed frame fitted into the ceiling and an optical unit with an aluminium body painted in a range of colours: beige/white, grey/white, black/orange, black/vert and black/blue. Tagora 80 and 270 offer a high-output spot light with aluminium optics. Tagora 270 uses a proprietary system based on a hybrid combined lens and reflector optic. This system helps to create defined narrow beams using high-powered LED modules of large dimensions. Tagora 570 and 970 come with a PMMA diffuser, offering a comfortable diffused light. LED versions use high-output sources. Integrated electronic power supply, dimmable or non-dimmable options, depending on the version. Only ceiling recessed installation allowed. Compliant with standard EN60598-1 and other specific standards.

TECHNICAL DRAWINGS

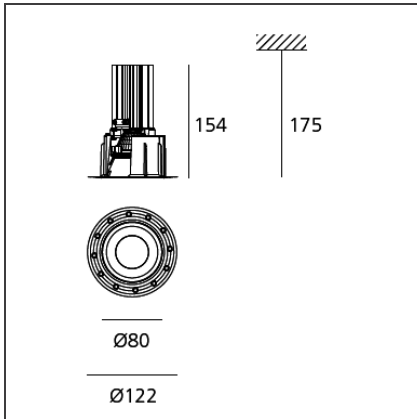

FEATURES

Article Code:	AB00201	Material:	Aluminium
Colour:	White	Series:	Indoor
Installation:	Recessed		

DIMENSIONS

Height:	cm 15.4	Cutout diameter:	cm 9.2
Weight:	kg 0.3	Cutout shape:	Rounded
Recessed depth:	cm 17.5	Glow Wire Test:	960

INCLUDED SOURCES

Category:	LED	Color temperature (K):	3000K
Number:	1	Color Tolerance:	MacAdam 3SDCM
Watt:	14W	CRI:	90
Type:	0	Service Life:	L70 (6K) 60000h
Class:	A		

LUMINAIRE

Power Supply:	Power supply supplied separately	Delivered lumens output (lm):	1110lm
Transformer availability:	Remote	CCT:	3000K
Watt:	14W	Efficiency:	75%
Voltage:	220V-240V	Efficacy:	79.34lm/W
		CRI:	90

ACCESSORIES



DRIVER cc 16W
350mA 220-240
156 52 26 1max
DALI
dimmable/Push
dali
M077401