

## Sharp - 5,5W 54° 2700K Trimless

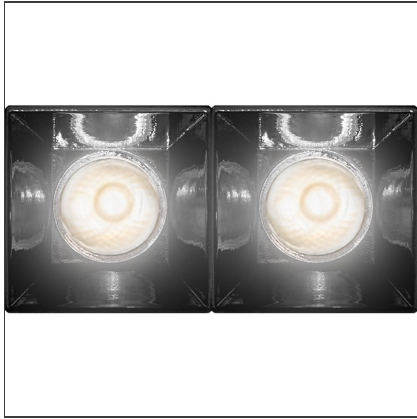

IP20  

### DESIGN BY

Carlotta de Bevilacqua

### DESCRIPTION

High-efficiency patented optical system that combines polynomial perspective to an element that shields geometrically the angle of vision of the beam. High uniformity of illumination and full emission control. Complete absence of possible light flaws as stains and multi-shadows. Recessed depth 60 mm. Suitable for a ceiling of 1 to 25 mm. Available in trim versions, trimless and SMD.

### TECHNICAL DRAWINGS

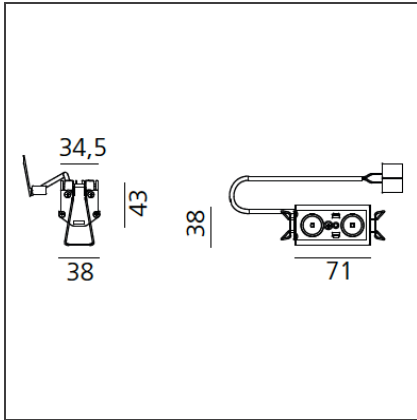

### FEATURES

<b>Article Code:</b>	AF55200	<b>Series:</b>	Indoor
<b>Colour:</b>	Black		
<b>Installation:</b>	Recessed, Ceiling		
<b>Environment:</b>	Indoor		

### DIMENSIONS

<b>Length:</b>	cm 7.1
<b>Width:</b>	cm 4.3
<b>Height:</b>	cm 3.8

### INCLUDED SOURCES

<b>Category:</b>	LED	<b>Color temperature (K):</b>	2700K
<b>Number:</b>	1		
<b>Watt:</b>	5,5W		
<b>Type:</b>	0		
<b>Class:</b>	A		

### LUMINAIRE

<b>Watt:</b>	6W	<b>Delivered lumens output (lm):</b>	366lm
		<b>CCT:</b>	2700K
		<b>Efficiency:</b>	73%
		<b>Efficacy:</b>	60.93lm/W
		<b>CRI:</b>	90

**ACCESSORIES**

Driver 7,2W  
900mA  
DV1001



Driver 25,2 W  
900mA  
DV1003



Screen 2x White  
AF95101



Screen 2x Black  
AF95104

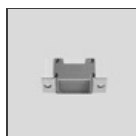

Recessed frame 2x  
AF90100



Sharping wall  
grazer lens Kit  
(4pcs) - 26°x70°  
elliptical lenses kit.  
It has to be used  
on top of S 20°  
reflectors to get  
an elliptical beam  
(greter axis along  
the module  
length). It contains  
4 lenses.  
AF06000