

Sharp - 5,5W 17° 3000K Trimless

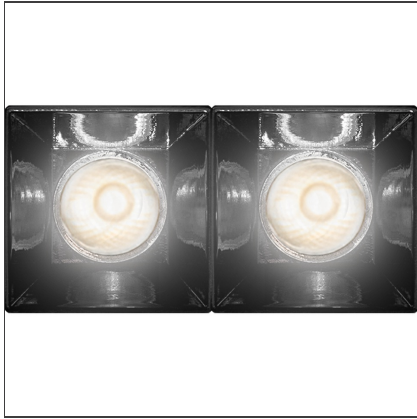

IP20  

DESIGN BY

Carlotta de Bevilacqua

DESCRIPTION

High-efficiency patented optical system that combines polynomial perspective to an element that shields geometrically the angle of vision of the beam. High uniformity of illumination and full emission control. Complete absence of possible light flaws as stains and multi-shadows. Recessed depth 60 mm. Suitable for a ceiling of 1 to 25 mm. Available in trim versions, trimless and SMD.

TECHNICAL DRAWINGS

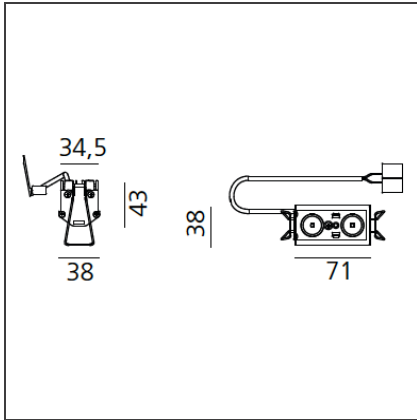

FEATURES

Article Code:	AF55300	Series:	Indoor
Colour:	Black		
Installation:	Recessed, Ceiling		
Environment:	Indoor		

DIMENSIONS

Length:	cm 7.1
Width:	cm 4.3
Height:	cm 3.8

INCLUDED SOURCES

Category:	LED	Color temperature (K):	3000K
Number:	1		
Watt:	5,5W		
Type:	0		
Class:	A		

LUMINAIRE

Watt:	6W	Delivered lumens output (lm):	402lm
		CCT:	3000K
		Efficiency:	76%
		Efficacy:	66.99lm/W
		CRI:	90

ACCESSORIES

Driver 7,2W
900mA
DV1001



Driver 25,2 W
900mA
DV1003



Screen 2x White
AF95101



Screen 2x Black
AF95104

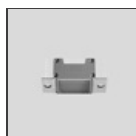

Recessed frame 2x
AF90100



Sharping wall
grazer lens Kit
(4pcs) - 26°x70°
elliptical lenses kit.
It has to be used
on top of S 20°
reflectors to get
an elliptical beam
(greter axis along
the module
length). It contains
4 lenses.
AF06000