

Sharp - 3W 54° 2700K Trimless



IP20  

DESIGN BY

Carlotta de Bevilacqua

DESCRIPTION

High-efficiency patented optical system that combines polynomial perspective to an element that shields geometrically the angle of vision of the beam. High uniformity of illumination and full emission control. Complete absence of possible light flaws as stains and multi-shadows. Recessed depth 60 mm. Suitable for a ceiling of 1 to 25 mm. Available in trim versions, trimless and SMD.

TECHNICAL DRAWINGS

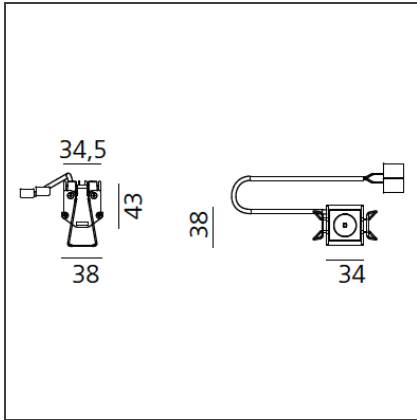

FEATURES

Article Code:	AF50200	Series:	Indoor
Colour:	Black		
Installation:	Recessed, Ceiling		
Environment:	Indoor		

DIMENSIONS

Length:	cm 3.4
Width:	cm 4.3
Height:	cm 3.8

INCLUDED SOURCES

Category:	LED	Color temperature (K):	2700K
Number:	1		
Watt:	3W		
Type:	0		
Class:	A		

LUMINAIRE

Watt:	3W	Delivered lumens output (lm):	183lm
		CCT:	2700K
		Efficiency:	73%
		Efficacy:	60.93lm/W
		CRI:	90

ACCESSORIES



Screen 1x White
AF95001



Driver 7,2W
900mA
DV1001



Driver 25,2 W
900mA
DV1003



Screen 1x Black
AF95004

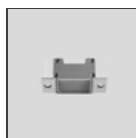

Recessed frame 1x
AF90000



Sharping wall grazer lens Kit (4pcs) - 26°x70° elliptical lenses kit. It has to be used on top of S 20° reflectors to get an elliptical beam (greter axis along the module lenght). It contains 4 lenses. AF06000