

Sharp - 11W 54° 3000K Trim White

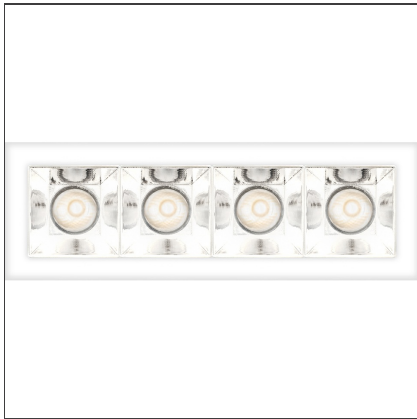

IP20  

DESIGN BY

Carlotta de Bevilacqua

DESCRIPTION

High-efficiency patented optical system that combines polynomial perspective to an element that shields geometrically the angle of vision of the beam. High uniformity of illumination and full emission control. Complete absence of possible light flaws as stains and multi-shadows. Recessed depth 60 mm. Suitable for a ceiling of 1 to 25 mm. Available in trim versions, trimless and SMD.

TECHNICAL DRAWINGS

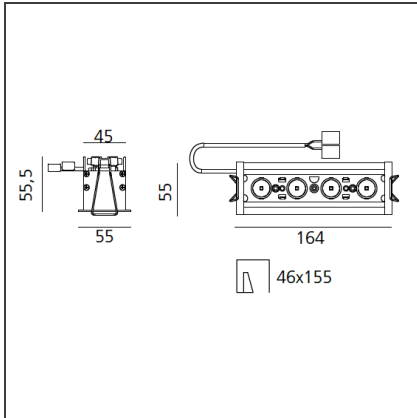

FEATURES

Article Code:	AF10501	Series:	Indoor
Colour:	White		
Installation:	Recessed, Ceiling		
Environment:	Indoor		

DIMENSIONS

Length:	cm 16.4
Width:	cm 5.5
Height:	cm 5.5

INCLUDED SOURCES

Category:	LED	Color temperature (K):	3000K
Number:	1		
Watt:	11W		
Type:	0		
Class:	A		

LUMINAIRE

Watt:	11W	Delivered lumens output (lm):	779lm
		CCT:	3000K
		Efficiency:	73%
		Efficacy:	70.81lm/W
		CRI:	90

ACCESSORIES

NO
IMAGE
AVAILABLE

Driver 25,2 W
900mA
DV1003



Screen 4x White
AF95201



Screen 4x Black
AF95204

NO
IMAGE
AVAILABLE

Driver 19,8 W
900mA
DV1002

NO
IMAGE
AVAILABLE

Sharping wall
grazer lens Kit
(4pcs) - 26°x70°
elliptical lenses kit.
It has to be used
on top of S 20°
reflectors to get
an elliptical beam
(greter axis along
the module
lenght). It contains
4 lenses.
AF06000