

## Picto 70 LED track horizontal - black 43° 3000K - Not dimmable



IP20   

### DESIGN BY

Studio Artemide

### DESCRIPTION

This range of professional projectors is distinguished by design, excellent performance and flexibility. Picto is a complete and versatile range, suitable for use in retail spaces, showrooms, museums or art galleries. Available in 3 sizes, installation options, designs, colours, optics and a wide range of accessories.

### TECHNICAL DRAWINGS

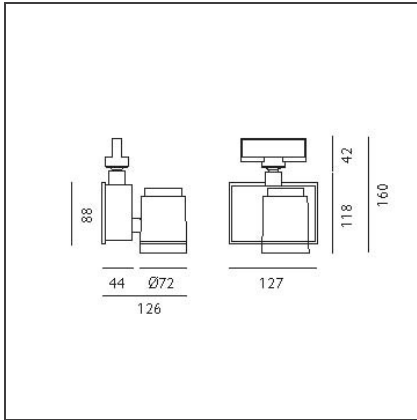

### FEATURES

<b>Article Code:</b>	AD05204	<b>Material:</b>	aluminum
<b>Colour:</b>	Black	<b>Series:</b>	Indoor
<b>Installation:</b>	Projector, Track, Ceiling	<b>Area contract:</b>	Hospitality, Retail, Culture
<b>Environment:</b>	Indoor		

### DIMENSIONS

<b>Length:</b>	cm 12.7	<b>Glow Wire Test:</b>	850
<b>Height:</b>	cm 16		
<b>Weight:</b>	kg 1.2		
<b>Inclination:</b>	-90+90		
<b>Rotation:</b>	cm 355		

### INCLUDED SOURCES

<b>Category:</b>	LED	<b>Color temperature (K):</b>	3000 K
<b>Number:</b>	1	<b>Color Tolerance:</b>	MacAdam 2SDCM
<b>Watt:</b>	20 W	<b>Service Life:</b>	Life L70 (6K) 50000h
<b>Type:</b>	0		
<b>Class:</b>	A		

### LUMINAIRE

<b>Power Supply:</b>	Power supply 220/240Vac 50/60Hz included	<b>Delivered lumens output (lm):</b>	1780lm
<b>Watt:</b>	20W	<b>CCT:</b>	3000K
		<b>Efficiency:</b>	87%
		<b>Efficacy:</b>	88.99lm/W
		<b>CRI:</b>	90

**ACCESSORIES**

Accessory-holder  
(white) +  
Adjustable dowser  
(black)  
M082817



Accessory for  
ceiling installation  
(black)  
L176330



Accessory-holder  
(bianco) +  
Projection lens for  
gobo. Customized  
gobo to be  
ordered  
separately  
M083817



Accessory-holder  
(white) + wall  
washer screen  
(black)  
M083017



Accessory-holder  
(white) +  
projection lens  
and framing  
device  
M083917