

Picto 125 track Tunable White - White 37° - Manual adjustment



IP20   **TW**

DESIGN BY

Studio Artemide

DESCRIPTION

This range of professional projectors is distinguished by design, excellent performance and flexibility. Picto is a complete and versatile range, suitable for use in retail spaces, showrooms, museums or art galleries. Available in 3 sizes, installation options, designs, colours, optics and a wide range of accessories.

TECHNICAL DRAWINGS

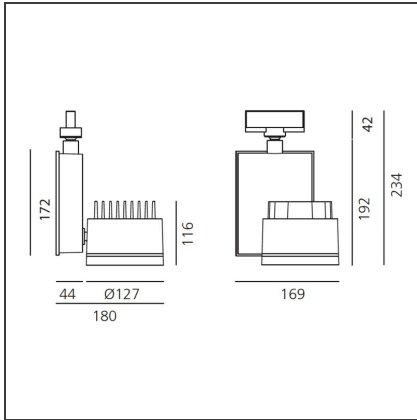

FEATURES

Article Code:	AD41201	Material:	Aluminum
Colour:	white	Series:	Indoor
Installation:	Projector, Track		

DIMENSIONS

Length:	cm 18	Glow Wire Test:	850
Height:	cm 23.4		
Weight:	kg 2.6		
Inclination:	-90+90		
Rotation:	cm 355		

INCLUDED SOURCES

Category:	LED	Color Rendering:	N/s
Number:	1	Color temperature (K):	2900-5500
Watt:	30 W	CRI:	>91 (min.)
Delivered lumens output (lm):	2428 lm	Efficacy:	81 lm/W
Type:	1		

LUMINAIRE

Power Supply:	electronic power supply included	Delivered lumens output (lm):	1134lm
Watt:	35W	CCT:	5200K
		Efficiency:	56%
		Efficacy:	32.39lm/W
		CRI:	93

Notes

Manual adjustment with potentiometer

ACCESSORIES

PICTO 125 -
Accessory-holder
+ wall washer
screen (black).
white
M083117



PICTO 125 -
Accessory-holder
+ wall washer
screen (black).
black
M083137



PICTO 125 -
Accessory-holder
(white) + Lens for
elliptical light
distribution.
M083417



PICTO 125 -
Accessory-holder
(black) + Lens for
elliptical light
distribution.
M083437



PICTO 125 -
Accessory-holder
+ Louvre (black).
white
M083317



PICTO 125 -
Accessory-holder
(white) +
Adjustable dowser
(black).
M082917



PICTO 125 -
Accessory-holder
+ Louvre (black).
black
M083337



PICTO 125 -
Accessory-holder
(black) +
Adjustable dowser
(black).
M082937