

**Pad 80 With fixed lenses - Black - 9,5W 4000K - 40°**



IP44

**DESIGN BY**

Carlotta de Bevilacqua

**DESCRIPTION**

Efficient, clear accent lighting, fixed and adjustable. 3 beam angles: 2x6°, 2x12°, 2x19°. Diffused ambient lighting (in fixed version). 2 colour temperatures: warm white (3000K) and neutral white (4000K) - CRI=80 (min.). Excellent lighting efficiency > 70lm/W. High adjustability: 360° rotation, +90°/-90° tilt angle. Fixed version available as IP44. Easy installation of light modules, no tools required. Lighting units available in 3 finishes: gloss aluminium, painted white, painted black. Structural elements of recessed-mounted version available in 3 sizes, for use with 1, 2, 3 and 2x2 modules. 3 compatible finishes (polished aluminium, white, and black). Housing of ceiling-mounted version available in 3 sizes (1, 2, 3 lighting units), and 3 compatible finishes (polished aluminium, white and black). Recessed-mounted version available as trimless or framed. Materials: body in anodized extruded aluminium, diffuser in opal polycarbonate. Complies with standard EN60598-1 and other specific standards.

**TECHNICAL DRAWINGS**

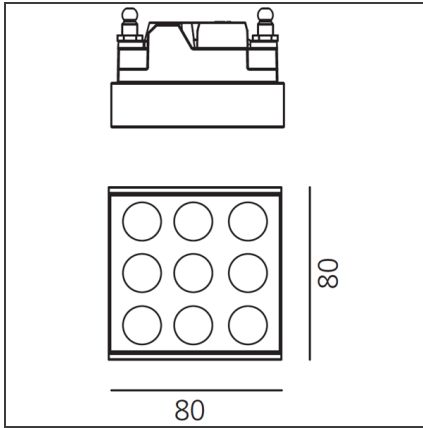

**FEATURES**

<b>Article Code:</b>	M245610	<b>Series:</b>	Indoor
<b>Colour:</b>	Black	<b>Area contract:</b>	Hospitality, null, Retail, Culture
<b>Installation:</b>	Projector, Recessed		

**DIMENSIONS**

<b>Length:</b>	cm 8	<b>Glow Wire Test:</b>	650
<b>Width:</b>	cm 8		
<b>Height:</b>	cm 2.5		
<b>Weight:</b>	kg 0.3		

**INCLUDED SOURCES**

<b>Category:</b>	LED	<b>Color temperature (K):</b>	4000K
<b>Number:</b>	1	<b>Color Tolerance:</b>	MacAdam 4SDCM
<b>Watt:</b>	9W	<b>CRI:</b>	=80 (min.)
<b>Delivered lumens output (lm):</b>	911lm	<b>Efficacy:</b>	101lm/W
<b>Type:</b>	0	<b>Service Life:</b>	L70(6K) > 60500h
<b>Class:</b>	A		

**LUMINAIRE**

<b>Watt:</b>	9.5W	<b>Delivered lumens output (lm):</b>	735lm
<b>Voltage:</b>	12V	<b>CCT:</b>	4000K
		<b>Efficiency:</b>	100%
		<b>Efficacy:</b>	77.37lm/W
		<b>CRI:</b>	0

**Notes**

LED 9W 2x19° 4000K