

## Pad 230V Ceiling Switchdim - 14,5W 4000K - 24°



IP40  Dimmerable: 

### DESIGN BY

Carlotta de Bevilacqua

### DESCRIPTION

Adjustable projector for 12x1,08W high performing LED. Body made from aluminium and translucent plastic material. White LED with Warm White or Neutral White tone. Choice of 3 beam angles. Tilt angle of up to 90°, rotation of up to 358°. Integral power supply unit. Complies with standard EN60598-1 and other specific standards. Dimming control via external push-button (not provided).

### TECHNICAL DRAWINGS

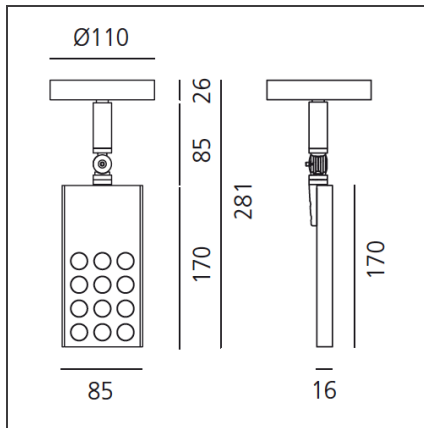

### FEATURES

<b>Article Code:</b>	M200301	<b>Material:</b>	Aluminium, plastic
<b>Colour:</b>	Translucent/anodized	<b>Series:</b>	Indoor
<b>Installation:</b>	Projector, Track, Recessed, Ceiling	<b>Area contract:</b>	Retail, Culture
<b>Environment:</b>	Indoor	<b>Emission:</b>	Accent Lighting

### DIMENSIONS

<b>Length:</b>	cm 8.5	<b>Glow Wire Test:</b>	650
<b>Width:</b>	cm 1.6		
<b>Height:</b>	cm 26		
<b>Weight:</b>	kg 0.7		
<b>Inclination:</b>	cm 9,090		
<b>Rotation:</b>	cm 358		

### INCLUDED SOURCES

<b>Category:</b>	LED	<b>Color temperature (K):</b>	4000K
<b>Number:</b>	1		
<b>Watt:</b>	12W		
<b>Type:</b>	0		
<b>Class:</b>	A		

### LUMINAIRE

<b>Power Supply:</b>	Electronic dimmable (Switchdim)	<b>Delivered lumens output (lm):</b>	880lm
<b>Watt:</b>	14.5W	<b>CCT:</b>	4000K
<b>Voltage:</b>	220V-240V	<b>Efficiency:</b>	100%
		<b>Efficacy:</b>	60.69lm/W
		<b>CRI:</b>	0

### Notes

LED 13W 2x12° 4000K - Dimmerabile (Switchdim)