

# Luceri LED Round Trimless - Faceted Mirror Optics 4000K - Driver 50W Undimmable



IP20/44 without screen - 20/54 with screen



## TECHNICAL DRAWINGS

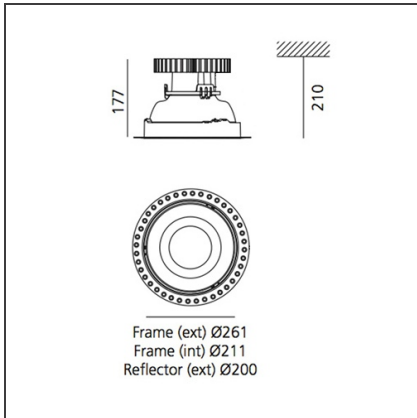

## DESIGN BY

Studio Artemide

## DESCRIPTION

Luceri LED and Kadro LED offer a modular range of professional downlighters, highly flexible, providing customisable lighting solutions for every need. Thanks to TrueWhite technology, colour temperature and colour rendering index are maintained constant throughout the lifespan of this product, guaranteeing a consistent light quality. The emission of versions with metal reflector is compliant with EN12464 and has UGR

## FEATURES

<b>Article Code:</b>	BB01100 DV1015	<b>Series:</b>	Indoor
<b>Installation:</b>	Recessed, Ceiling	<b>Area contract:</b>	Hospitality, Office
<b>Environment:</b>	Indoor		

## DIMENSIONS

<b>Width:</b>	cm 17.7	<b>Cutout diameter:</b>	cm 21.6
<b>Height:</b>	cm 21	<b>Cutout shape:</b>	Rounded
<b>Weight:</b>	kg 1.6		

## INCLUDED SOURCES

<b>Category:</b>	LED	<b>Color temperature (K):</b>	4000K
<b>Number:</b>	1	<b>CRI:</b>	90
<b>Watt:</b>	max 54W		
<b>Type:</b>	0		

## LUMINAIRE

<b>Transformer availability:</b>	50W	<b>Delivered lumens output (lm):</b>	4828lm
<b>Watt:</b>	54W	<b>CCT:</b>	4000K
		<b>Efficiency:</b>	83%
		<b>Efficacy:</b>	89.41lm/W
		<b>CRI:</b>	90

## Notes

Driver 220/240Vac 50/60Hz supplied separately. To be completed with recessed frame.

**ACCESSORIES**

Sharp edge trim  
M240500



Support with  
rounded edge trim  
M240600



Transparent  
polycarbonate  
screen  
M239200



Accessory for  
ceiling installation  
M239820



Opal screen in  
PMMA  
M239700



Prismoptic screen  
in polycarbonate  
M239600