

Hila Pole 350 4000K Anthracite gray

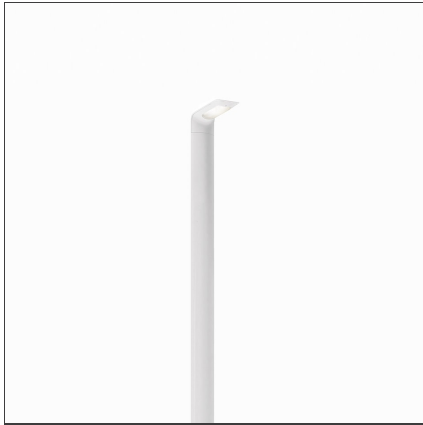

IP65  

DESIGN BY

Carlo Colombo

DESCRIPTION

Composed by lamp and ground support pole.

Lamp unit is die-cast EN-AB 47100 aluminium.

UV resistant diffuser in shock resistant polycarbonate with satiny finish.

Support pole h=350cm above ground +50cm underground in extruded EN-AW 6060 aluminium, chromate treated and painted.

TECHNICAL DRAWINGS

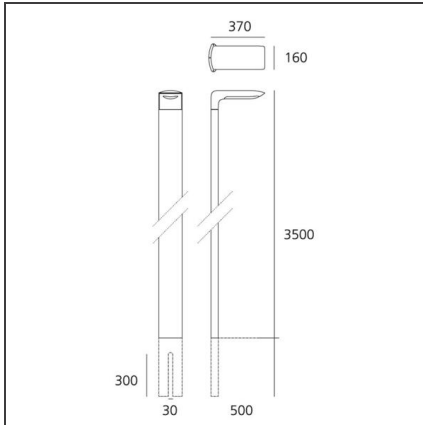

FEATURES

Article Code:	T085920	Material:	Aluminum, polycarbonate
Colour:	Gray/white	Series:	Scenarios
Installation:	Bollard, Pole, Floor, Wall	Emission:	Direct
Environment:	Outdoor		

DIMENSIONS

Length:	cm 37	Impact Resistance:	IK10
Width:	cm 16	Glow Wire Test:	650
Height:	cm 350		
Depth:	cm 30		

INCLUDED SOURCES

Category:	LED	Color temperature (K):	4000K
Number:	1	CRI:	80
Watt:	24W		
Type:	0		
Class:	A		

LUMINAIRE

Watt:	24W	Delivered lumens output (lm):	1311lm
Voltage:	220V-240V	CCT:	4000K
		CRI:	80

Notes

Underground pole included.
Effective power 24W.

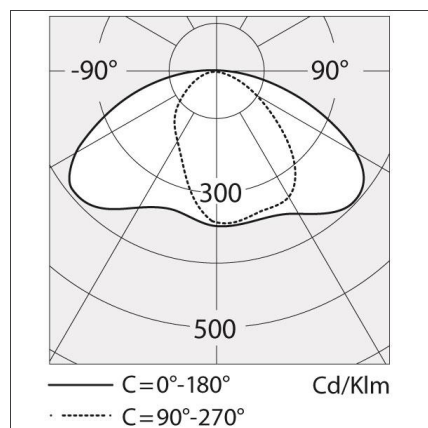
LIGHT DISTRIBUTION

We reserve the right to change our product specifications.
Please visit www.artemide.com for the latest product information

March 2019