

Epulo 18 flood 40° Anthracite gray



IP65   

DESIGN BY

Ernesto Gismondi

DESCRIPTION

Light fixture with adjustable direct emission, with high-performance LED light sources. Floor, wall and eaves installation. 2 sizes: Epulo 13 and Epulo 18. Available in two finishes: grey-white painted and anthracite grey painted. Composed by lighting unit, terminal board and fixing bracket. Rotation on the base +/-180°, side body tilt +/-45° and front body tilt +0/-90 by means of a spherical joint allowing an accurate adjustment. Body and terminal board in EN AB44100 aluminium, fixing bracket in stainless steel, silicone gaskets. Electronic ballast integrated in the body. Silkscreened tempered glass siliconed flush with the body to avoid backwater. IP67 connector for electric connection to the mains, it can be housed in the terminal board compartment and is suitable for cables with a diameter of 5-13.5mm. PMMA lenses in 3 different versions of beams. White monochromatic LEDs available in 3 colour temperatures: Warm = 3000K Neutral = 4000K Cold = 6000K Screws in AISI 316 stainless steel. The components in die-cast aluminium and the steel bracket are painted with 3-stage outdoor treatment: nanotechnologies, antioxidant primer, polyester paint. Technical features of light fixtures in compliance with EN60598-1 and part 2-5. IP Rating IP65. Insulation class I.

TECHNICAL DRAWINGS

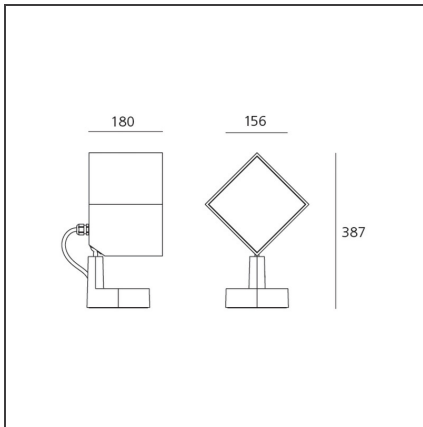

FEATURES

Article Code:	T418839W10	Material:	Aluminum, tempered glass
Colour:	Anthracite gray	Series:	Outdoor
Installation:	Floor, Wall, Ceiling		

DIMENSIONS

Length:	cm 15.6	Impact Resistance:	IK06
Width:	cm 18		
Height:	cm 38.7		

INCLUDED SOURCES

Category:	LED	Color temperature (K):	3000K
Number:	1	CRI:	80
Watt:	38W		
Type:	0		
Class:	A		

LUMINAIRE

Watt:	38W	Delivered lumens output (lm):	2110lm
Voltage:	220V-240 V	CCT:	3000K
		Efficiency:	100%
		Efficacy:	57.04lm/W
		CRI:	80