

Cata TIR Suspension - 3000K + Lens 4°



IP20  Dimmerable: 

DESIGN BY

Carlotta de Bevilacqua

DESCRIPTION

Interchangeable optical unit through a 'twist & lock' mechanism. Defined, concentrated light beams thanks to an innovative collimation system. 2 beam angles: 2x3,5°, 2x8°. Excellent quality of light: Cata Tuneable White: adjustable colour temperature from 2700K to 5700K CRI >93 (min.) Cata Stable White: available as warm white (3000K) and neutral white (4000K) – CRI=80 (min.). Rotation of 360°, tilt angle of +90°/-90° 2 installation options: with adaptor for 3-circuit track, or base plate for ceiling mounting. Ultra-flat power source (8mm height): DALI dimmable as standard, DALI8 interface hub for Tuneable White version. Materials : optic in transparent and metallic polycarbonate, heat sink in die-cast gloss aluminium, feeder/power supply in transparent polycarbonate, arm in die-cast gloss aluminium. Complies with standard EN60598-

TECHNICAL DRAWINGS

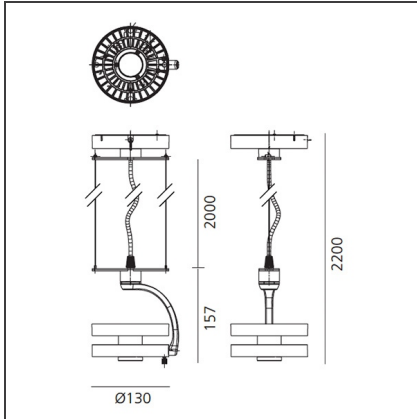

FEATURES

Article Code:	M0671W81 M109500	Series:	Indoor
Colour:	Polished aluminium		
Installation:	Track, Suspension, Ceiling		

DIMENSIONS

Height:	cm 15.7
Weight:	kg 0.8
Base Diameter:	cm 13
Inclination:	-90+90
Rotation:	cm 360
Max Height from ceiling:	cm 2,000

INCLUDED SOURCES

Category:	LED	Color temperature (K):	3000K
Number:	1	Color Tolerance:	MacAdam 2SDCM
Watt:	22W	CRI:	90
Type:	0	Service Life:	L70(6K) 36000h
Class:	A		

LUMINAIRE

Watt:	22W	Delivered lumens output (lm):	1446lm
		CCT:	3000K
		Efficiency:	80%
		Efficacy:	65.72lm/W
		CRI:	90

Notes

If there is no DALI-SwitchDim bus, the luminaire can be dimmed using the button on the device

ACCESSORIES

Accessories holder
M057080



Adjustable
dowsers
M059910

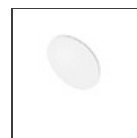

Lens for elliptical
emission
M282007

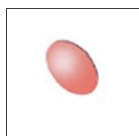

Chromatic filter
yellow
M281745

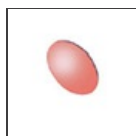

Chromatic filter
red
M281755

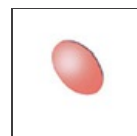

Chromatic filter
blue
M281735



Anti-dazzle louvre
M282100

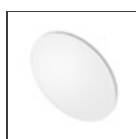

Soft filter
M056807