

Cata Ceiling Fix Stable White - 30W - 4000K + Lens 9°



IP20  Dimmerable: 

DESIGN BY

Carlotta de Bevilacqua

DESCRIPTION

Interchangeable optical unit through a 'twist & lock' mechanism. Defined, concentrated light beams thanks to an innovative collimation system. 2 beam angles: 2x3,5°, 2x8°. Excellent quality of light: Cata Tuneable White: adjustable colour temperature from 2700K to 5700K CRI >93 (min.) Cata Stable White: available as warm white (3000K) and neutral white (4000K) – CRI=80 (min.). Rotation of 360°, tilt angle of +90°/-90° 2 installation options: with adaptor for 3-circuit track, or base plate for ceiling mounting. Ultra-flat power source (8mm height): DALI dimmable as standard, DALI8 interface hub for Tuneable White version. Materials : optic in transparent and metallic polycarbonate, heat sink in die-cast gloss aluminium, feeder/power supply in transparent polycarbonate, arm in die-cast gloss aluminium. Complies with standard EN60598-

TECHNICAL DRAWINGS

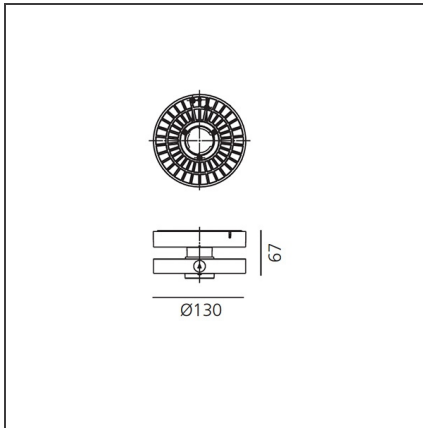

FEATURES

Article Code:	M0677N81 M057500	Material:	Aluminium, glass
Colour:	Polished aluminium	Series:	Indoor
Installation:	Track, Suspension, Ceiling		

DIMENSIONS

Height:	cm 6.7	Impact Resistance:	850°
Weight:	kg 0.7		
Inclination:	-90+90		

INCLUDED SOURCES

Category:	LED	Color temperature (K):	4000K
Number:	1	Color Tolerance:	MacAdam 3SDCM
Watt:	30W	CRI:	=80 (min.)
Type:	0	Service Life:	L70(6K)>36000h
Class:	A		

LUMINAIRE

Watt:	30W	Delivered lumens output (lm):	1194lm
		CCT:	4000K
		Efficiency:	44%
		Efficacy:	39.81lm/W
		CRI:	80

Notes

If there is no DALI-SwitchDim bus, the luminaire can be dimmed using the button on the device