

A.39 Suspension/Ceiling - Structural Module 1184mm - Direct Emission - 4000K - Undimmable - Silver

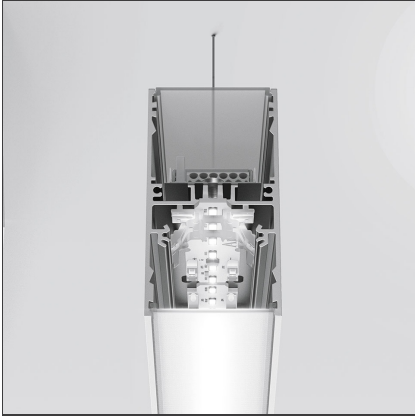

IP20 

DESIGN BY

Carlotta de Bevilacqua

DESCRIPTION

Optimized version in line applications with wide lengths. Diffusing direct and direct + indirect emission. Recessed trim, trimless, suspension and ceiling versions. Dimmable and non dimmable in two CCT 3000K and 4000K versions.

TECHNICAL DRAWINGS

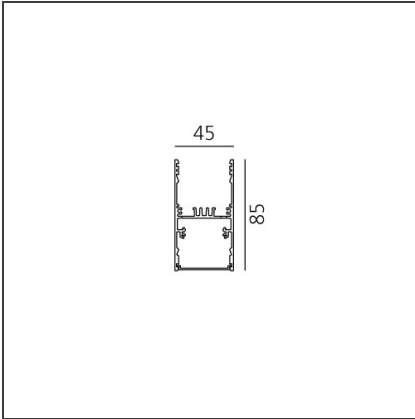

FEATURES

Article Code:	AT13305	Series:	Indoor
Colour:	Silver		
Installation:	Ceiling		
Environment:	Indoor		

DIMENSIONS

Length:	cm 118
Width:	cm 4.5
Height:	cm 8.5

INCLUDED SOURCES

Category:	LED	Color temperature (K):	4000K
Number:	1		
Watt:	34W		
Type:	0		
Class:	A		

LUMINAIRE

Watt:	34W	Delivered lumens output (lm):	1977lm
		CCT:	4000K
		CRI:	80

ACCESSORIES

NO
IMAGE
AVAILABLE

A.39 - Mechanical
joint including 1
suspension cable
AT09500

NO
IMAGE
AVAILABLE

A.39 - Ceiling
bracket and
mechanical joint
AT09501

NO
IMAGE
AVAILABLE

A.39 - End Ceiling
Bracket (2x)
AT09502

NO
IMAGE
AVAILABLE

A.39 - Opal
Diffuser in
Polycarbonate -
L=10000mm
AT10000

NO
IMAGE
AVAILABLE

A.39 -
Undimmable
Feeding kit
including 2
suspension cables
(3 poles) 2000mm
(H)
AT10400

NO
IMAGE
AVAILABLE

A.39 - Opal
Diffuser in
Polycarbonate -
L=1184mm
AT10100

NO
IMAGE
AVAILABLE

A.39 - Opal
Diffuser in
Polycarbonate -
L=25000mm
AT10800

NO
IMAGE
AVAILABLE

A.39 - Opal
Diffuser in
Polycarbonate -
L=50000mm
AT10900

NO
IMAGE
AVAILABLE

A.39 - End Cap (Kit
2x) - Silver
AT09405