

A.39 Recessed - Structural Module Trim 1184mm 4000K Undimmable Silver

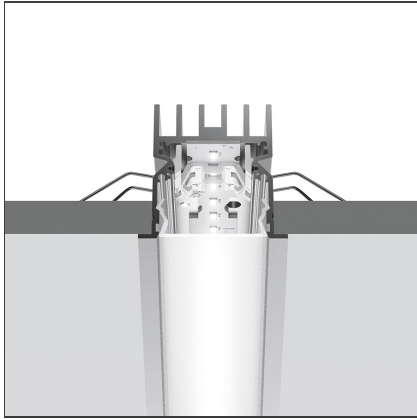

IP20

DESIGN BY

Carlotta de Bevilacqua

DESCRIPTION

Optimized version in line applications with wide lengths. Diffusing direct and direct + indirect emission. Recessed trim, trimless, suspension and ceiling versions. Dimmable and non dimmable in two CCT 3000K and 4000K versions.

TECHNICAL DRAWINGS

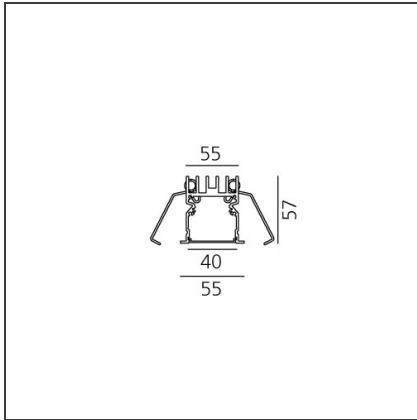

FEATURES

Article Code:	AT05305	Series:	Indoor
Colour:	Silver	Emission:	Direct
Installation:	Recessed		
Environment:	Indoor		

DIMENSIONS

Length: cm 118

INCLUDED SOURCES

Category:	LED	Color temperature (K):	4000K
Number:	1		
Watt:	33W		
Type:	0		
Class:	A		

LUMINAIRE

Watt:	33W	Delivered lumens output (lm):	2099lm
		CCT:	4000K
		CRI:	80

ACCESSORIES

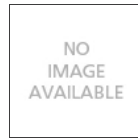

A.39 Recessed - Trim End Cap (Kit 2x) - Up to 15m - Silver
AT09105

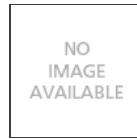

A.39 Recessed - Trim End Cap (Kit 2x) - Up to 35m - Silver
AT09205

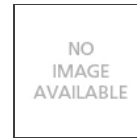

A.39 - Opal Diffuser in Polycarbonate - L=10000mm
AT10000

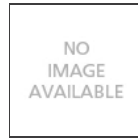

A.39 - Opal Diffuser in Polycarbonate - L=2368mm
AT10200

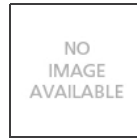

A.39 - Opal Diffuser in Polycarbonate - L=25000mm
AT10800



A.39 - Opal Diffuser in Polycarbonate - L=2960mm
AT10300



A.39 Recessed - Trim End Cap (Kit 2x) - Up to 5m - Silver
AT09005



A.39 - Opal Diffuser in Polycarbonate - L=1184mm
AT10100



A.39 Recessed - Trimless Frame Kit - L=1488mm
AT04000



A.39 Recessed - Trimless Frame Kit - L=4736mm
AT04100



A.39 - Opal Diffuser in Polycarbonate - L=50000mm
AT10900



A.39 Recessed - Frame Cap 2x
AT09300



End Cap (x2)
AT09301