

PRODUCT DATA SHEET

Felsina palo HIE 70W Fixed



DESIGN BY :

Ernesto Gismondi
1994

MATERIALS :

Hot-galvanized steel, die-cast aluminium, anodized aluminium, tempered glass

DESCRIPTION :

Light fixture with direct emission and fixed projector. Materials: 3/4/5-meter underground pole in hot-galvanized and painted steel, lamp unit in painted die-cast EN-AB 46100 aluminium; reflector in bright anodized aluminium; moulded prismatic diffuser in sodium-calcium tempered glass; AISI 316 stainless steel screws and silicone seal gaskets. Painting is obtained with 3-stage outdoor treatment: nanotechnologies, antioxidant primer, polyester paint.

Light emission



Direct and Direct/Indirect

IP 65  

TECHNICAL DATA SHEET

Features

Product name:	Felsina palo HIE 70W Fixed
Article Code:	T001700 + T003100
Colour:	Antigua grey
Material:	Hot-galvanized steel, die-cast aluminium, anodized aluminium, tempered glass
Series:	Outdoor
Environment:	Outdoor

OPTICS

Emission:	Direct and Direct/Indirect
-----------	----------------------------

DIMENSIONS

Width:	(cm) 26
Height:	(cm) 322
Max Extension Height:	(cm) 522
Recessed depth:	(cm) 50
Cutout shape:	



LAMPS NOT INCLUDED

Category:	HQI
Number:	1
Lbs:	Hie
Watt:	70
Socket:	E27
Type:	Mcs
Colour Rendering:	1b
Colour temperature (K):	3000

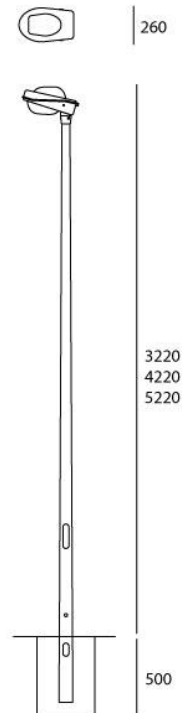
Dimensions



LAMP

IP 65  

ELECTRICAL

Voltage: 220-240V

Installation

HIE 100W direct emission			Lighting application		
h	L	a	Em	E_{max}	E_{min}
3.22 m	3.5 m	11.9 m	39 lux	130 lux	4 lux
4.22 m	4.5 m	15.6 m	22 lux	75 lux	3 lux
5.22 m	5.5 m	19.3 m	14 lux	48 lux	1.5 lux

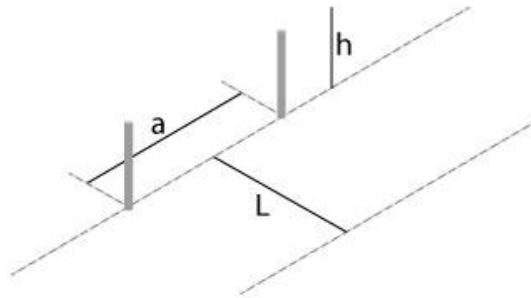

ACCESSORIES



FELSINA PALO 4M
INTERR+PORTT001710



FELSINA PALO 5M
INTERR+PORTT001720

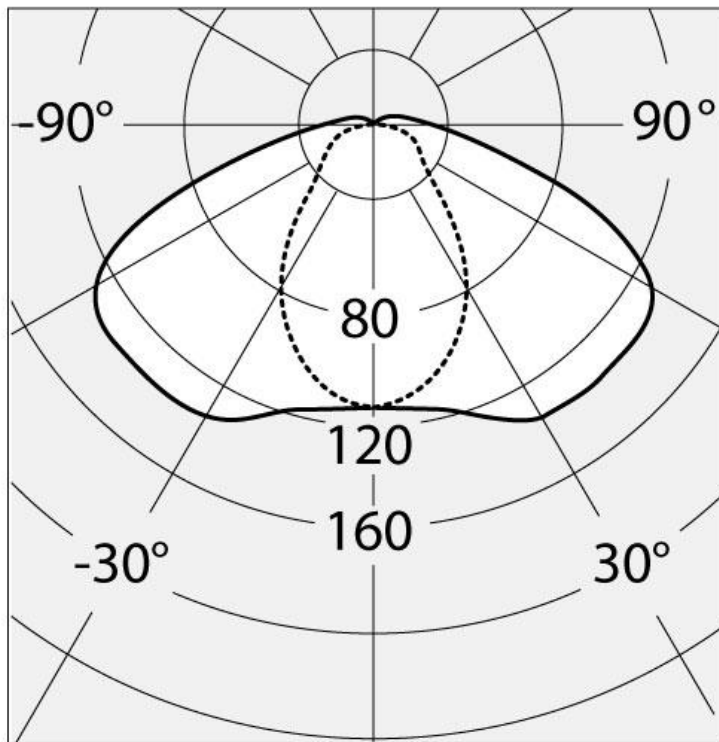

— C=0°-180° Cd/Klm

- - - C=90°-270°

Polar curve

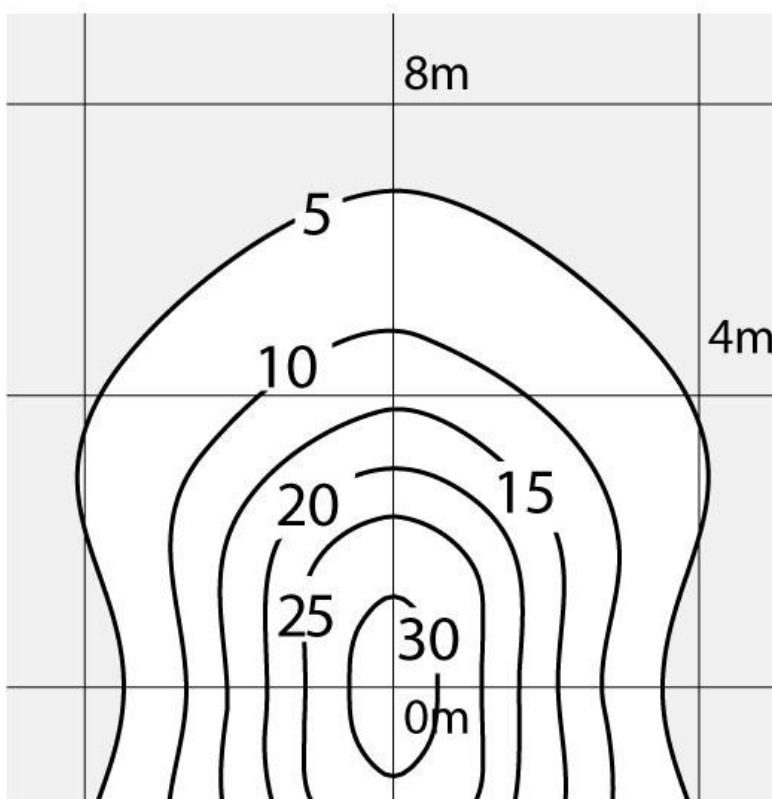

$\alpha = 73^\circ \times 37^\circ$

Light cone

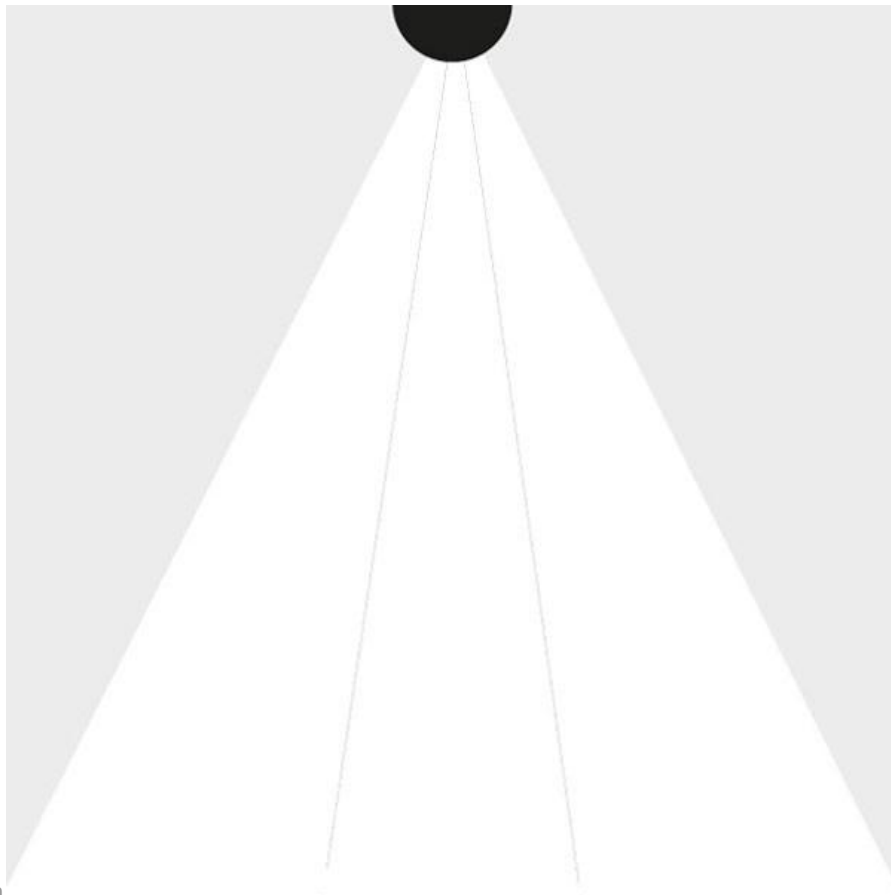

Light beam